



**LVD-P** is the Leader View portrait configuration for medium and large wall frame / directory signs.

The LVD-P is offered in four standard width options: 320, 400, 500 and 600mm with endless height options.

This is a light weight yet rigid sign frame with a curved face structure that comes with machined anodized aluminum end caps, allowing indoor and outdoor use.

All presented height options are commonly used sizes; however, customized heights are available upon request.

The unique frame profiles' design allows the use of face inserts (printed paper, ADA in photopolymer, engraved PVC, etched thin, silk printed plaques and many more flexible substrates) up to 3mm thick. Printed paper is another option using a protective clear lens.

The installation is very simple; a double sided self-adhesive tape can be applied to the back of the frame, or concealed screws can be used as well, drilling them through the built-in channels.

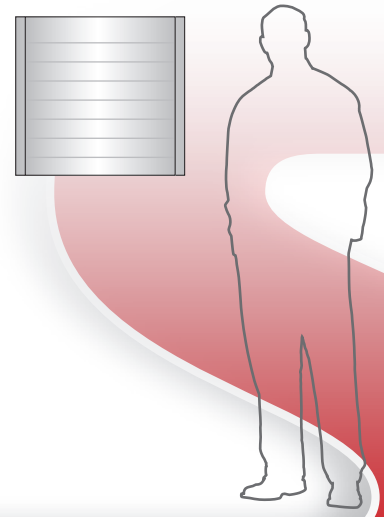



1

A Multiline individual anodized aluminum stripes with direct application of vinyl graphics. Installation using concealed screws through the built-in channels

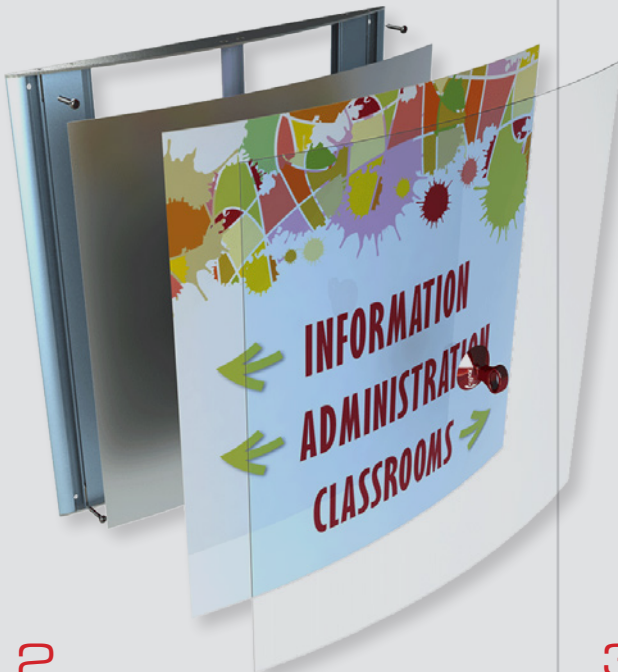

2

A printed paper insert with protective clear lens. Installation using concealed screws through the built-in channels

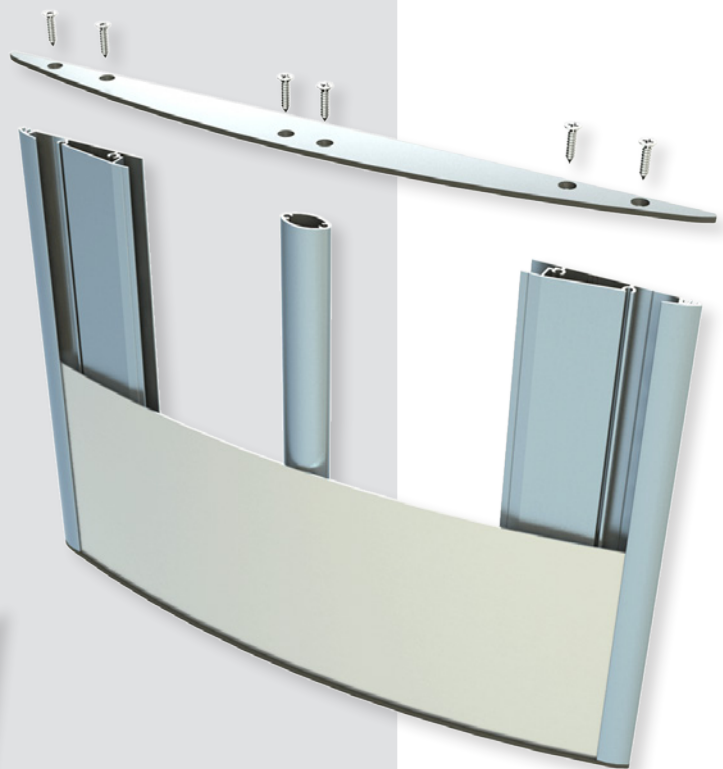

3

A lightweight aluminum body frame structure with machined anodized aluminum end caps.

LVD-P-W-H-FT	
LVD	System Type - Leader View Director
P	Sign layout - Portrait
W	Sign Unit Width - mm
H	Sign Unit Height - mm
FT	Face type AA=Anodised Aluminum AAS=Anodised Aluminum Stripes AC=Aluminum+Clear cover



## LVD-P-320

Commonly used unit height (other unit height can be ordered by demand)

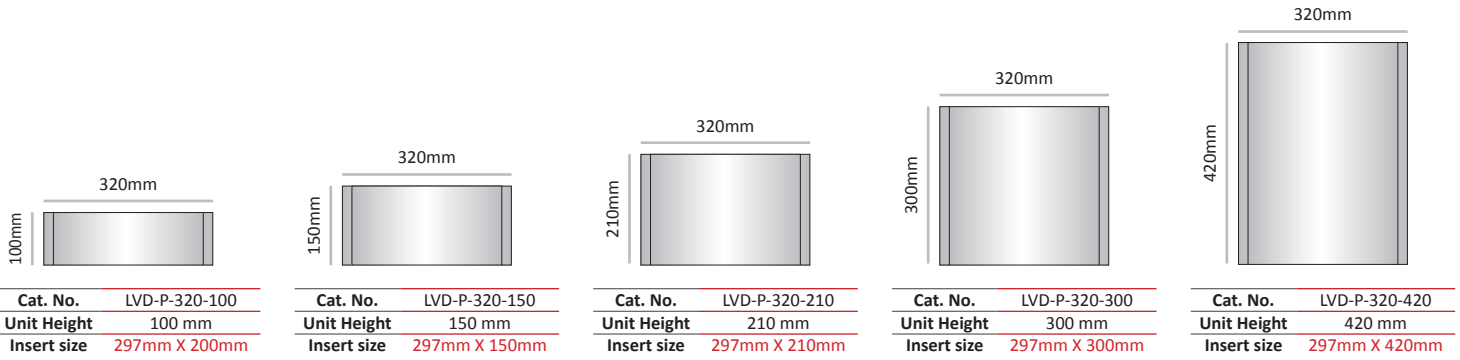

## LVD-P-400

Commonly used unit height (other unit height can be ordered by demand)

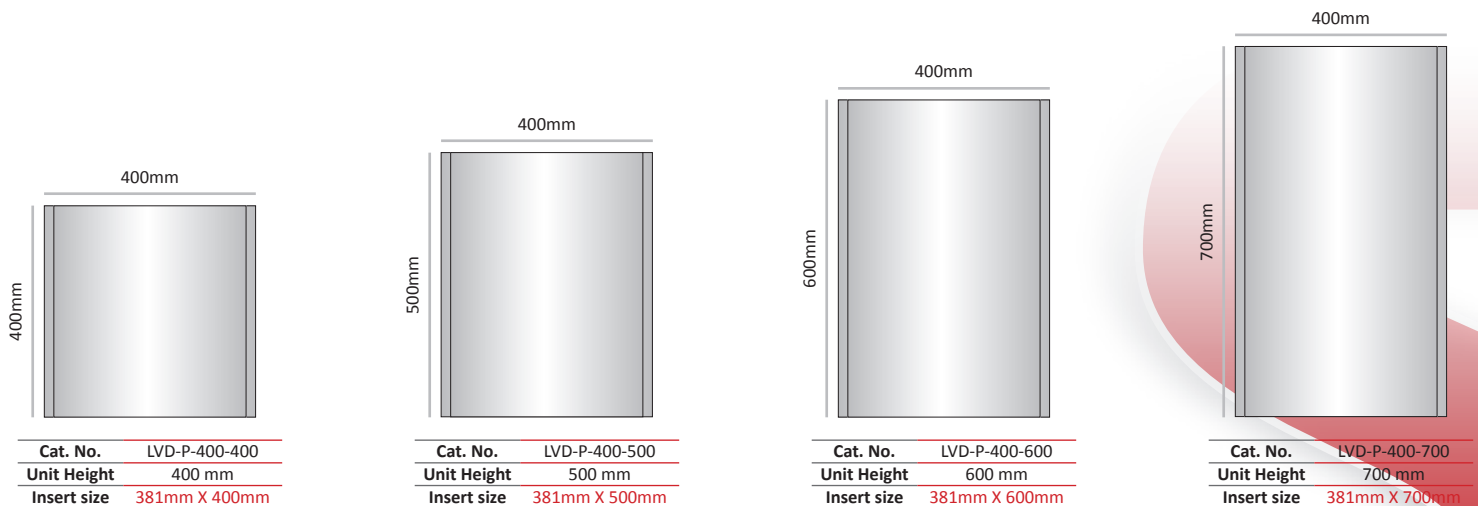
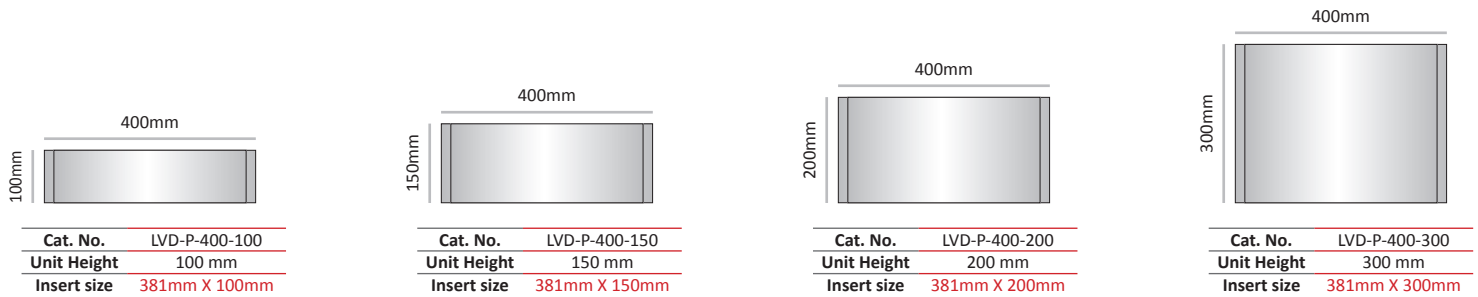



# LVD-P-500

Commonly used unit height (other unit height can be ordered by demand)

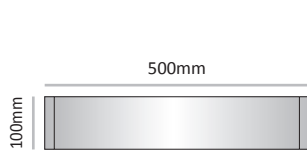

<b>Cat. No.</b>	LVD-P-500-100
<b>Unit Height</b>	100 mm
<b>Insert size</b>	484mm X 100mm

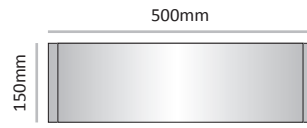

<b>Cat. No.</b>	LVD-P-500-150
<b>Unit Height</b>	150 mm
<b>Insert size</b>	484mm X 150mm

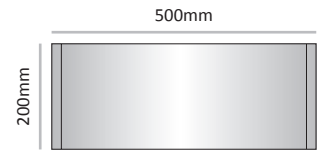

<b>Cat. No.</b>	LVD-P-500-200
<b>Unit Height</b>	200 mm
<b>Insert size</b>	484mm X 200mm

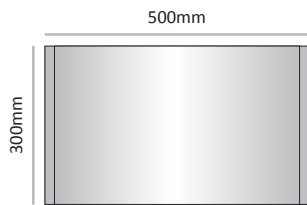

<b>Cat. No.</b>	LVD-P-500-300
<b>Unit Height</b>	300 mm
<b>Insert size</b>	484mm X 300mm

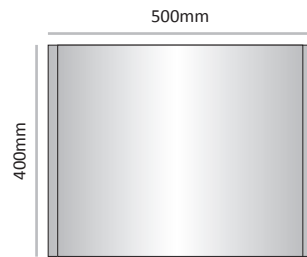

<b>Cat. No.</b>	LVD-P-500-400
<b>Unit Height</b>	400 mm
<b>Insert size</b>	484mm X 400mm

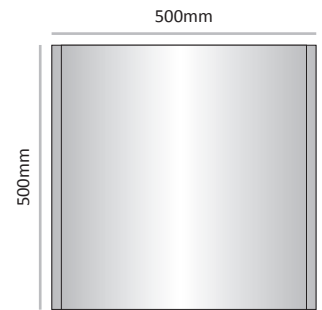

<b>Cat. No.</b>	LVD-P-500-500
<b>Unit Height</b>	500 mm
<b>Insert size</b>	484mm X 500mm

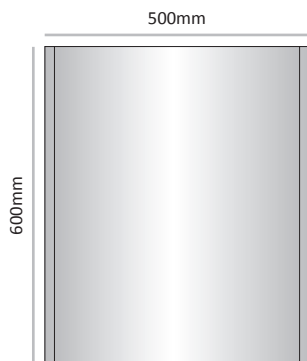

<b>Cat. No.</b>	LVD-P-500-600
<b>Unit Height</b>	600 mm
<b>Insert size</b>	484mm X 600mm

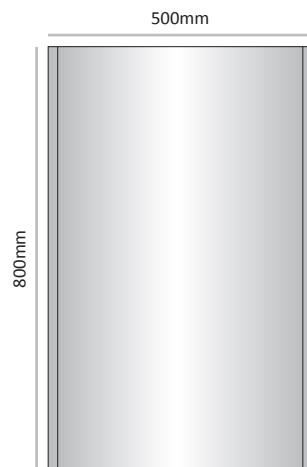

<b>Cat. No.</b>	LVD-P-500-800
<b>Unit Height</b>	800 mm
<b>Insert size</b>	484mm X 800mm

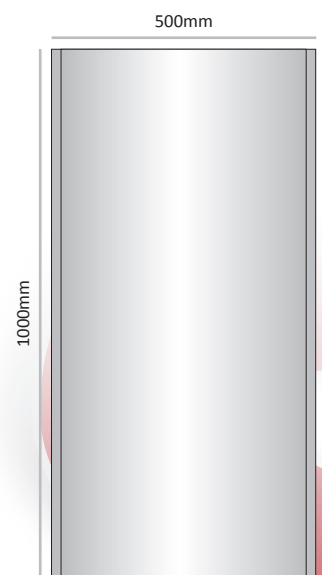

<b>Cat. No.</b>	LVD-P-500-1000
<b>Unit Height</b>	1000 mm
<b>Insert size</b>	484mm X 1000mm



# LVD-P-600

Commonly used unit height (other unit height can be ordered by demand)

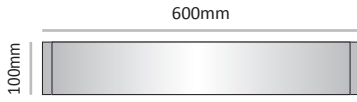

Cat. No.	LVD-P-600-100
Unit Height	100 mm
Insert size	584mm X 100mm

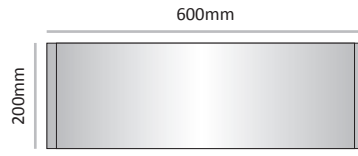

Cat. No.	LVD-P-600-200
Unit Height	200 mm
Insert size	584mm X 200mm

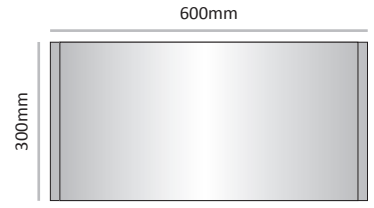

Cat. No.	LVD-P-600-300
Unit Height	300 mm
Insert size	584mm X 300mm

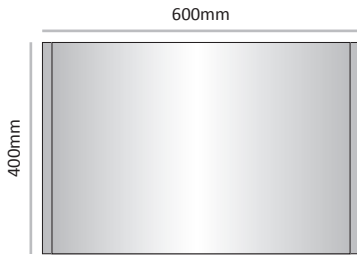

Cat. No.	LVD-P-600-400
Unit Height	400 mm
Insert size	584mm X 400mm

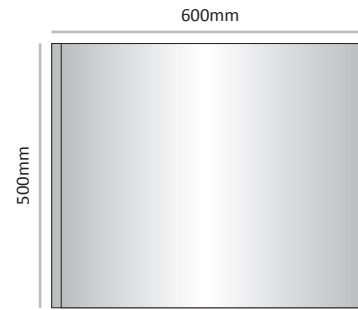

Cat. No.	LVD-P-600-500
Unit Height	500 mm
Insert size	584mm X 500mm

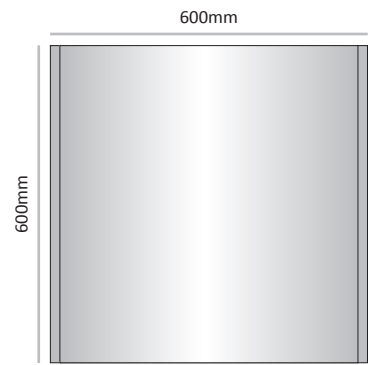

Cat. No.	LVD-P-600-600
Unit Height	600 mm
Insert size	584mm X 600mm

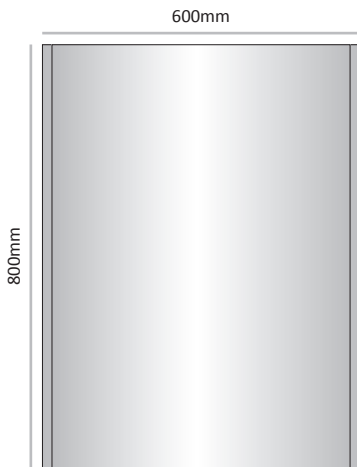

Cat. No.	LVD-P-600-800
Unit Height	800 mm
Insert size	584mm X 800mm



Cat. No.	LVD-P-600-1000
Unit Height	1000 mm
Insert size	584mm X 1000mm

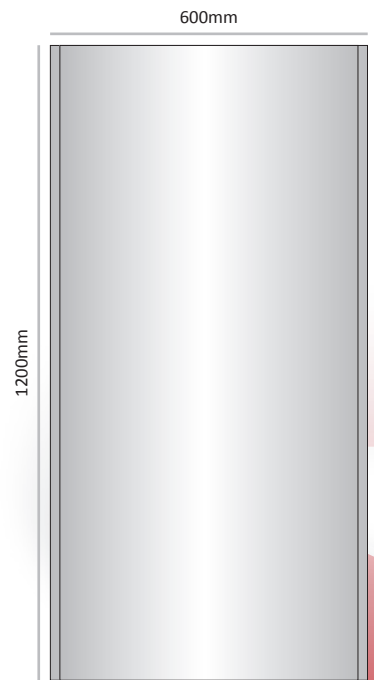

Cat. No.	LVD-P-600-1200
Unit Height	1200 mm
Insert size	584mm X 1200mm



## LVD-P-700

Commonly used unit height (other unit height can be ordered by demand)

Unit Height	Cat. No.	Unit Height	Cat. No.	Unit Height	Cat. No.
150mm	LVD-P-700-150	200mm	LVD-P-700-200	300mm	LVD-P-800-300
400mm	LVD-P-700-400	500mm	LVD-P-700-500	600mm	LVD-P-700-600
800mm	LVD-P-700-800	1000mm	LVD-P-700-1000	1200mm	LVD-P-700-1200

Detailed description of the table content: The table displays six different unit heights for the LVD-P-700 sign frame. Each unit is shown as a gray rectangular panel with a width of 700mm. The unit heights are 150mm, 200mm, 300mm, 400mm, 500mm, 600mm, 800mm, 1000mm, and 1200mm. For each unit, the catalog number, unit height, and insert size (684mm X unit height) are provided. The insert size is consistently 684mm wide and matches the unit height. The units are arranged in three rows: the first row contains 150mm, 200mm, and 300mm; the second row contains 400mm, 500mm, and 600mm; and the third row contains 800mm, 1000mm, and 1200mm. Each unit diagram shows the 700mm width and the specific unit height. Below each diagram is a table with three rows: 'Cat. No.', 'Unit Height', and 'Insert size'.



# LVD-P-800

Commonly used unit height (other unit height can be ordered by demand)

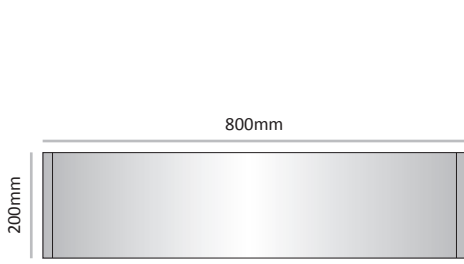

Cat. No.	LVD-P-800-200
Unit Height	200 mm
Insert size	785mm X 200mm

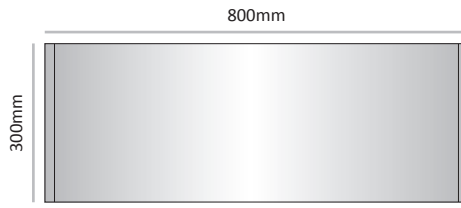

Cat. No.	LVD-P-800-300
Unit Height	300 mm
Insert size	785mm X 300mm

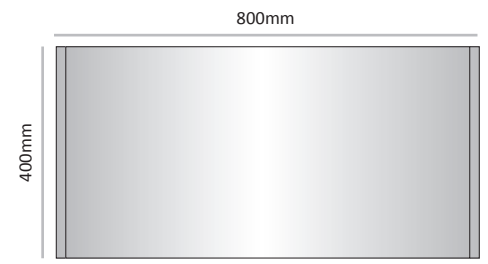

Cat. No.	LVD-P-800-400
Unit Height	400 mm
Insert size	785mm X 400mm

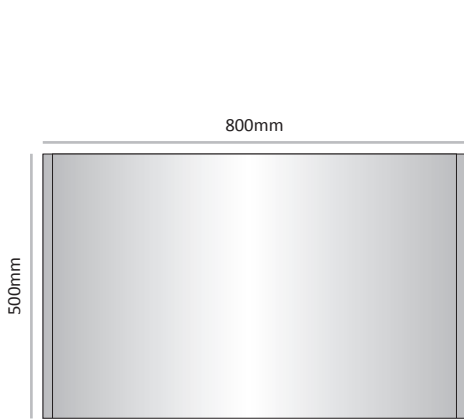

Cat. No.	LVD-P-800-500
Unit Height	500 mm
Insert size	785mm X 500mm

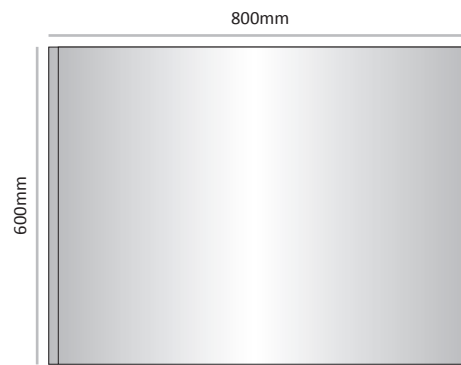

Cat. No.	LVD-P-800-600
Unit Height	600 mm
Insert size	785mm X 600mm

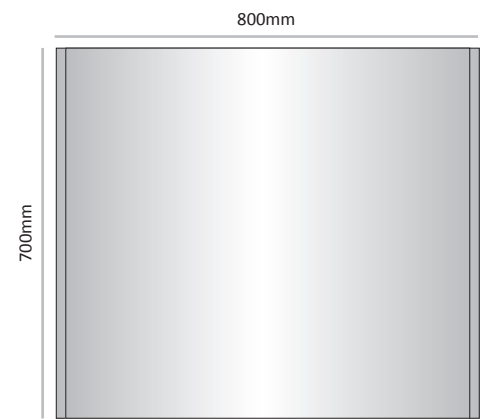

Cat. No.	LVD-P-800-700
Unit Height	700 mm
Insert size	785mm X 700mm

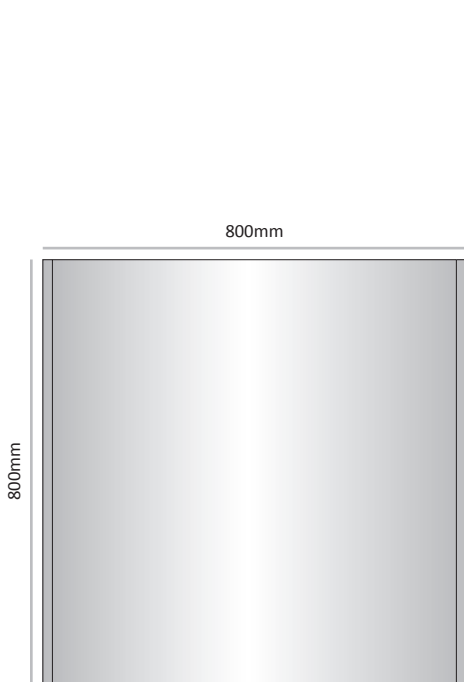

Cat. No.	LVD-P-800-800
Unit Height	800 mm
Insert size	785mm X 800mm

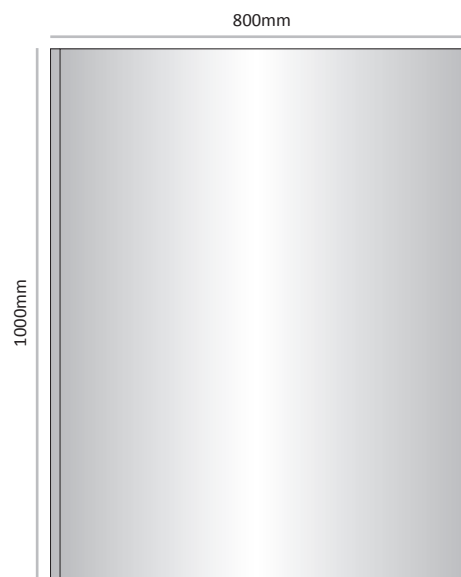

Cat. No.	LVD-P-800-1000
Unit Height	1000 mm
Insert size	785mm X 1000mm

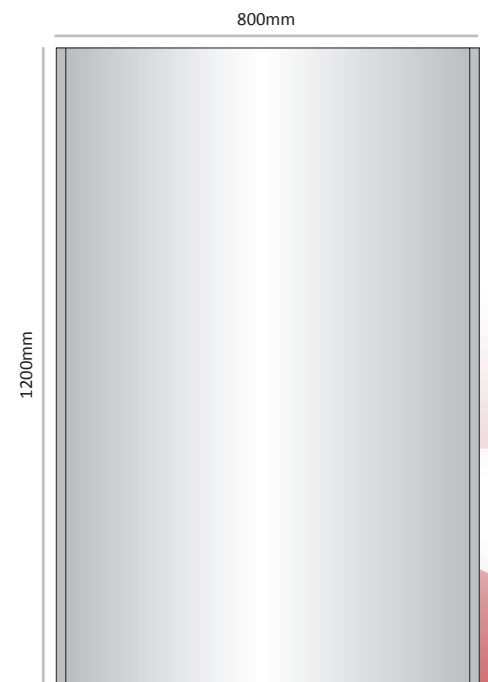

Cat. No.	LVD-P-800-1200
Unit Height	1200 mm
Insert size	785mm X 1200mm



# LVD-P-900

Commonly used unit height (other unit height can be ordered by demand)

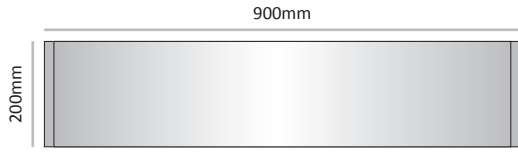

<b>Cat. No.</b>	LVD-P-900-200
<b>Unit Height</b>	200 mm
<b>Insert size</b>	885mm X 200mm

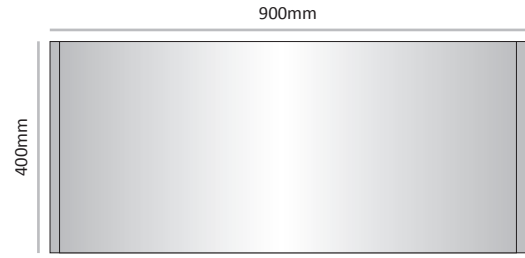

<b>Cat. No.</b>	LVD-P-900-400
<b>Unit Height</b>	400 mm
<b>Insert size</b>	885mm X 400mm

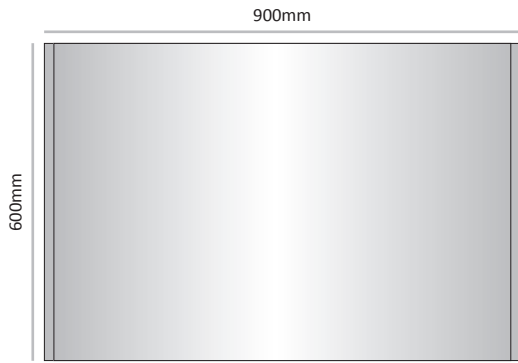

<b>Cat. No.</b>	LVD-P-900-600
<b>Unit Height</b>	600 mm
<b>Insert size</b>	885mm X 600mm

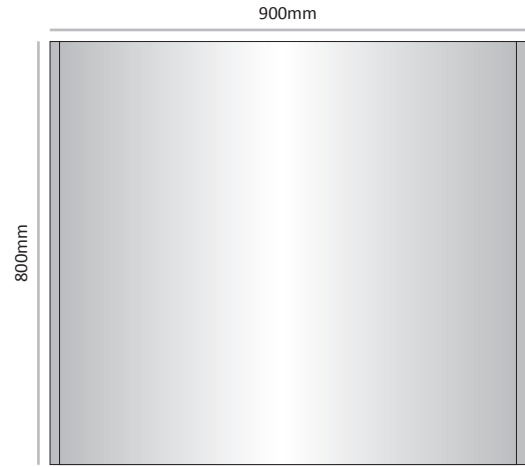

<b>Cat. No.</b>	LVD-P-900-800
<b>Unit Height</b>	800 mm
<b>Insert size</b>	885mm X 800mm

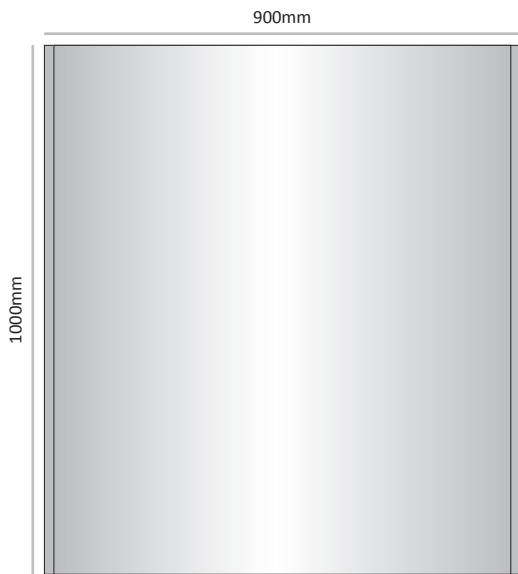

<b>Cat. No.</b>	LVD-P-900-1000
<b>Unit Height</b>	1000 mm
<b>Insert size</b>	885mm X 1000mm

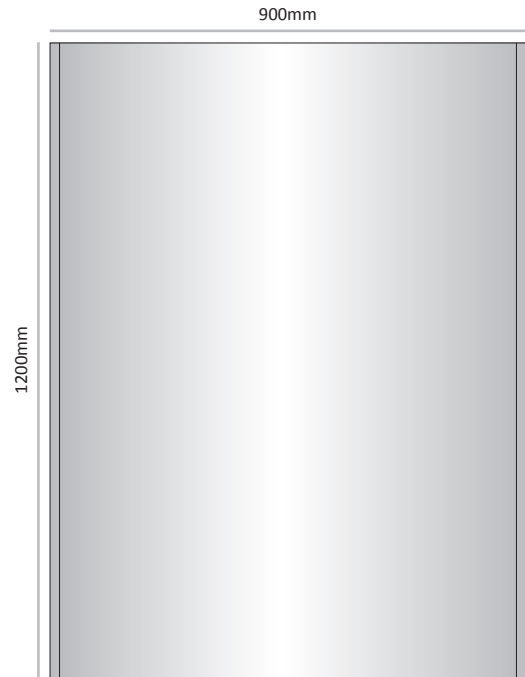

<b>Cat. No.</b>	LVD-P-900-1200
<b>Unit Height</b>	1200 mm
<b>Insert size</b>	885mm X 1200mm





# LVD-P-1000

Commonly used unit height (other unit height can be ordered by demand)

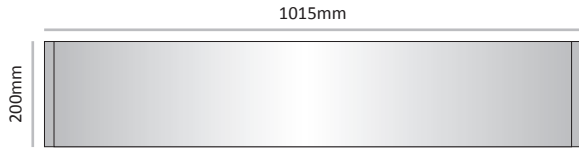

Cat. No.	LVD-P-1000-200
Unit Height	200 mm
Insert size	1000mm X 200mm

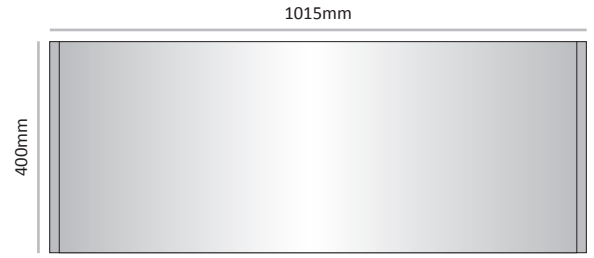

Cat. No.	LVD-P-1000-400
Unit Height	400 mm
Insert size	1000mm X 400mm

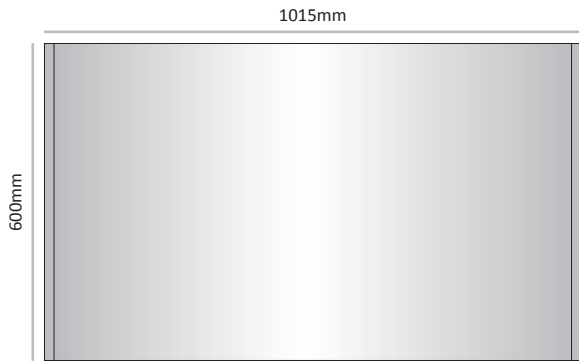

Cat. No.	LVD-P-1000-600
Unit Height	600 mm
Insert size	1000mm X 600mm

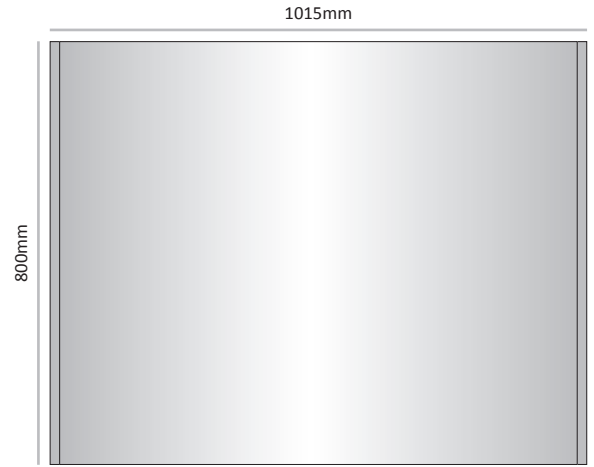

Cat. No.	LVD-P-1000-800
Unit Height	800 mm
Insert size	1000mm X 800mm

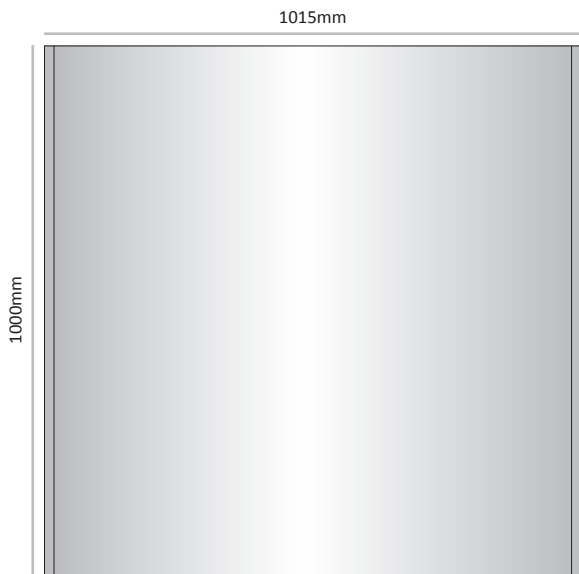

Cat. No.	LVD-P-1000-1000
Unit Height	1000 mm
Insert size	1000mm X 1000mm

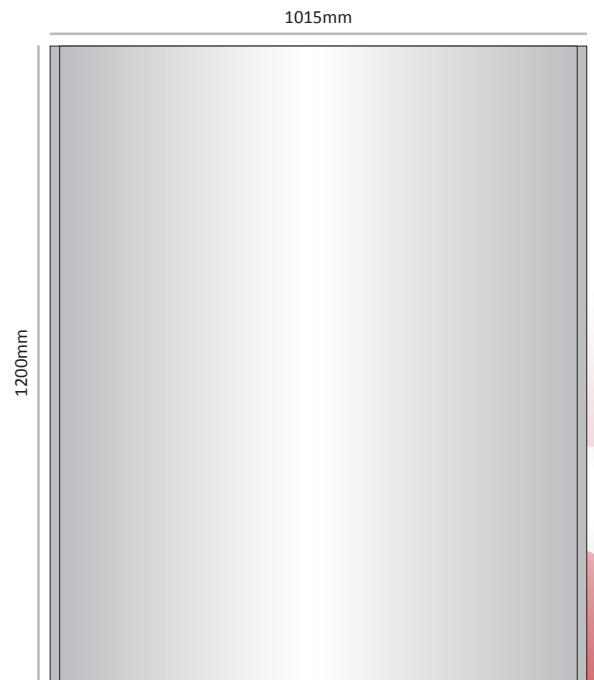

Cat. No.	LVD-P-1000-1200
Unit Height	1200 mm
Insert size	1000mm X 1200mm

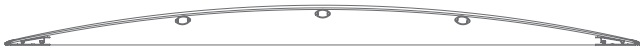

## LVD-P-1200

Commonly used unit height (other unit height can be ordered by demand)

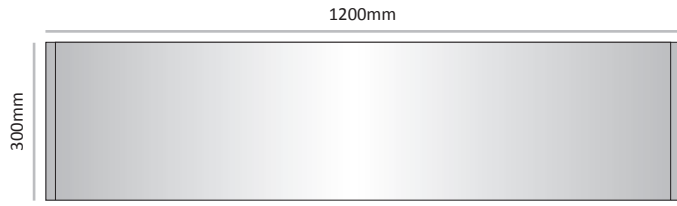

Cat. No.	LVD-P-1200-300
Unit Height	300 mm
Insert size	1185mm X 300mm

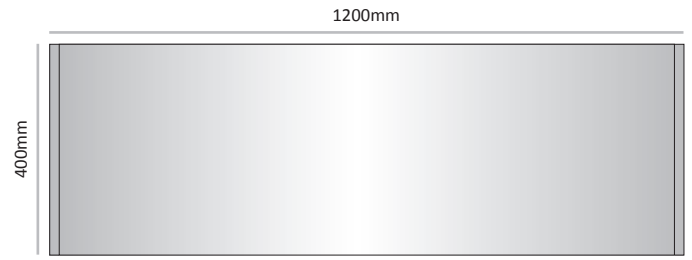

Cat. No.	LVD-P-1200-400
Unit Height	400 mm
Insert size	1185mm X 400mm

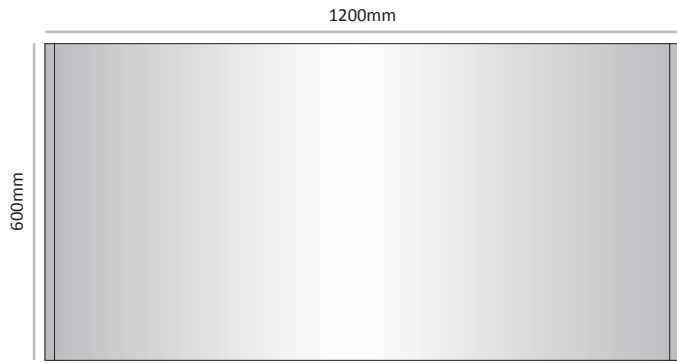

Cat. No.	LVD-P-1200-600
Unit Height	600 mm
Insert size	1185mm X 600mm

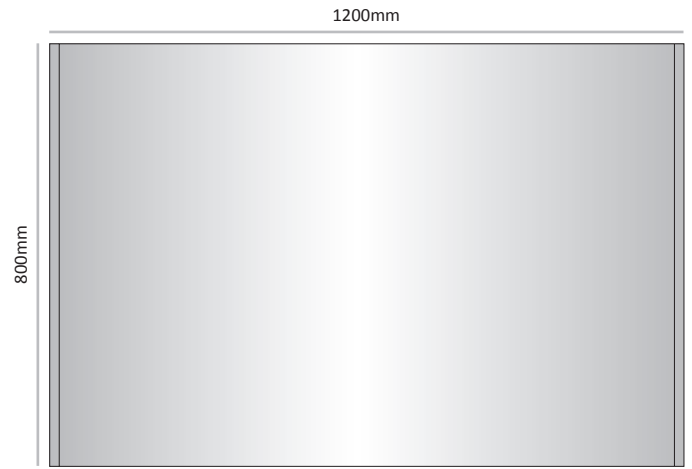

Cat. No.	LVD-P-1200-800
Unit Height	800 mm
Insert size	1185mm X 800mm

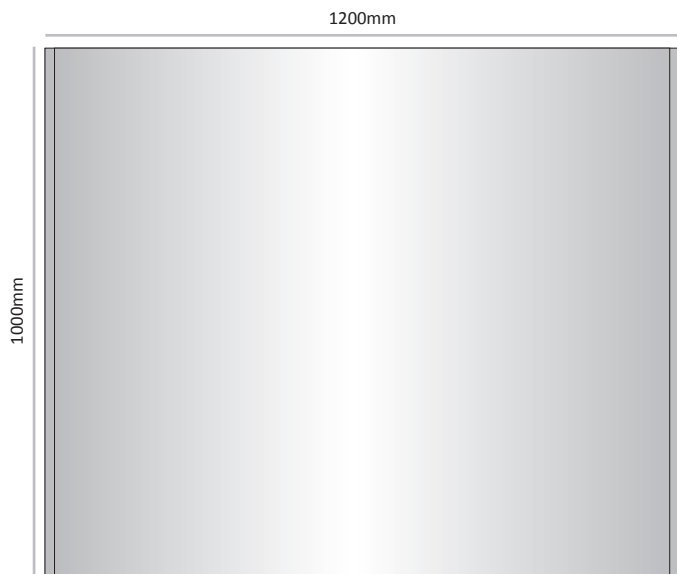

Cat. No.	LVD-P-1200-1000
Unit Height	1000 mm
Insert size	1185mm X 1000mm

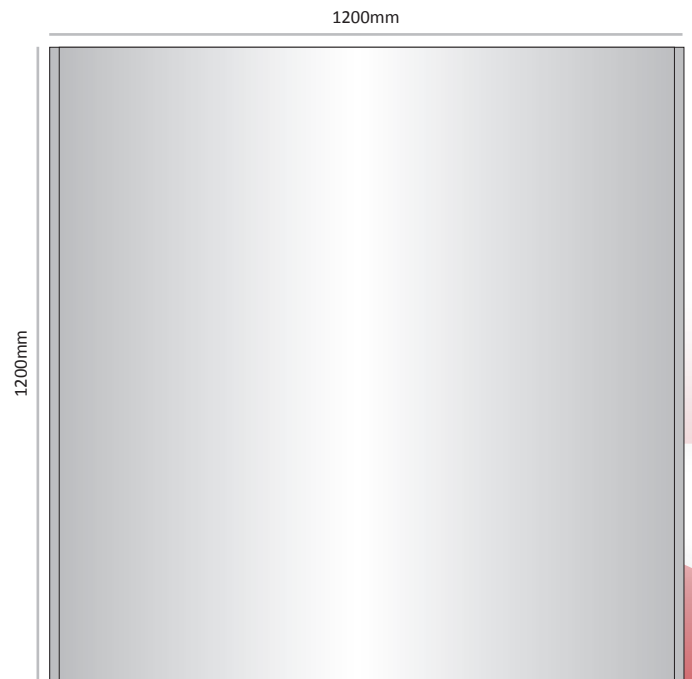

Cat. No.	LVD-P-1200-1200
Unit Height	1200 mm
Insert size	1185mm X 1200mm